

SHARP

Be Original.

Supplemental information for PN-CD701

Ver.1.0

SHARP corporation

30, Oct., 2019

It is supplemental document of both setup and operation manual.

There are reference information which are not described in manual, please utilize it as well as setup / operation manual.

1. System requirement
2. Condition of connecting Mac / Chrome OS
3. Outline of USB type-C
4. Conditions of network connections to the PN-CD701
 - 4-1. Common functions of both LAN ports
 - 4-2. Use case
 - 4-3. Technical background
 - 4-3-1. Network isolation
 - 4-3-2. Network requirement for WSI (IoT sensor data)
 - 4-3-3. Other network requirements
5. Notes on updating firmware
 - 5-1. OOB
 - 5-2. USB Flash Drive
 - 5-3. OTA Firmware Updates
6. How to enable LAN 1 Network
 - 6-1. Procedure to enable LAN1 Network
 - 6-2. LAN 1 network always on
 - 6-3. Matrix of LAN1 Network status
7. Notes on camera attached to PN-CD701
8. Tips
9. Detail of setting menu items

1. System requirement

System requirement

Hardware	Must have a USB 2.0 compliant port.
Operating system	Windows 8.1 (32-bit or 64-bit version), Windows 10 (32-bit or 64-bit version) (Windows 10 recommended.)
	macOS v10.12, v10.13
	Google Chrome OS Version 75 or later

*MacOS is supported with mouse operation and single touch.
Chrome book is supported multi touch(touch digitizer), but Touch pen does not work.

<Referenced information>

PN-CD701 , because of featuring 4K resolution, should be recommended the controller which has sufficient ability for 4K resolution.

“Sufficient” means

- 60Hz refresh rate on 4K resolution.
- Smooth operation on 4K resolution in the application produced by Microsoft(i.e. Windows Ink).

2. Condition of connecting Mac / Chrome OS

PN-CD701 is designed for using with Windows devices.
It supports both Mac OS and Chromebook but there are some limitations.

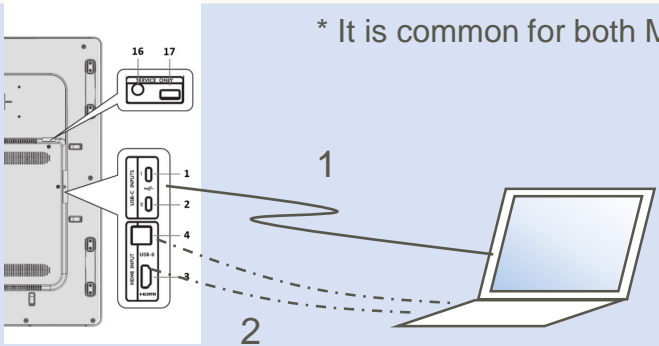
	Mac OS	Chromebook
How to connect	 <p>* It is common for both Mac OS and Chrome book</p> <p><u>Connection method 1: USB type-C (If the device has USB type-C port))</u> Connect by using USB type-C cable</p> <ul style="list-style-type: none"> - Video, sound, touch signal, LAN connection and also power delivery are available by the cable - Touch function works with no special driver <p><u>Connection method 2: HDM and USB A-B cable (If the device does NOT have USB type-C port))</u> Connect by using both HDMI and USB A-B cable</p> <ul style="list-style-type: none"> - Video and sound are available by HDMI cable - Touch signal and LAN connection are available by USB A-B cable - Power delivery is NOT available (AC adapter required) - Touch function works with no special driver 	
Limitation	<ul style="list-style-type: none"> • Works as mouse operation / single touch 	<ul style="list-style-type: none"> • Support multi touch (touch digitizer), but Touch pen does NOT work.
Technical Background	<ul style="list-style-type: none"> • Mac OS is the system which does not support touch operation, essentially. • Some of our IWB product supports Mac OS with Multi touch operation, but it emulates function of touch pad and it requires special driver. • It is not provided special driver because it is designed for Windows. 	<ul style="list-style-type: none"> • PN-CD701 supports Windows pen-digitizer input by touch hardware itself. It is distinguished whether finger touch or pen touch. • In case of using it with Chromebook, touch pen does not work because Chrome OS can not recognize pen-digitizer input.

3. Outline of USB type-C

USB type-C is a new standard which has various capabilities for connecting IT devices. Some of these capabilities are unique to USB type-C. Please see descriptions below how to utilize new functions.

Major functions of USB type-C

- Connect devices and data transfer (Same as USB 2.0 but higher speed)
- “DP alt mode” which means that it works as a DisplayPort to transmit video.
- “Power delivery” function enables user to supply power up to 100W (20V/5A)

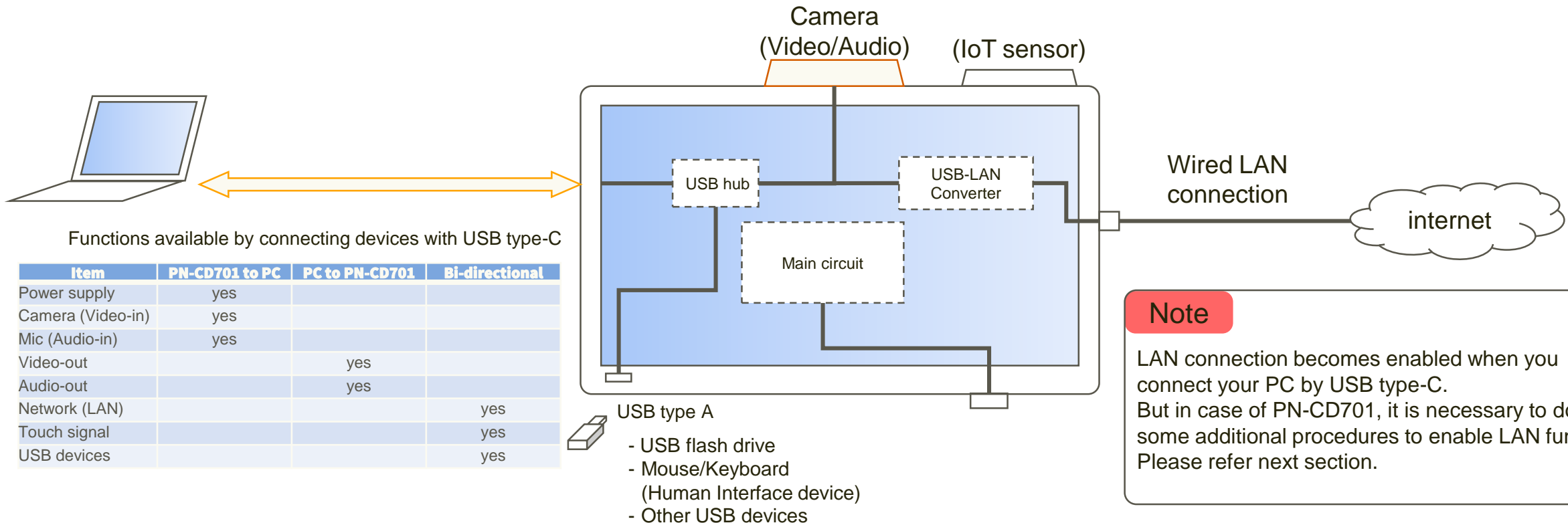

3. Outline of USB type-C

Caution for running USB type-C cable

- ◆ When a USB type-C cable is connected, the functions shown in the table below are available.

Function of USB type-C	Available/ Not Available
DP Alt mode(Video stream)	Available
Network *	Available
Touch (Data Transport)	Available
Power Delivery	Available(MAX 60W)

Table. Function of USB type-C

- ◆ The USB Type C cable may also provide power to the connected PC. Contact your local electrical contractor before running the supplied cable under carpets, behind walls or over ceiling tiles, as regulations may vary.
- ◆ If you use 8m USB type-C cable(PN-ZU01), please observe the following points. It may cause a fire.
 - Do not use the USB type-C cable rolled/tied up.
 - Do not lay the USB type-C cable under the carpet.
 - Do not be routed inside the building structure (e.g., walls, ceilings, etc.).
 - If a cable is damaged, never use the cable.
 - If you connect this cable to PN-CD701, please fix the cable with a clamp.
 - This cable has a “SOURCE” connector and a “DISPLAY” connector. Be careful not to mistake the orientation.



Figure. Fixed the cable



Figure. Connector

3. Outline of USB type-C

Caution for running USB type-C cable

- ◆ USB type-C Out can be used for video output.
 - Only video signals are output from USB type-C Out.
 - The signal of Wireless Cast can not be output.
 - Do not convert the cable from the USB type-C cable.
 - Only the same display or allowed display is supported for the display connected to the Out side.

◆ About “Multi board”

You can display video on a second device using USB-C Out.
The USB-C cable enables touch without connecting a touch cable.



If you want to touch on the second display, please connect as follows.
*Touch settings on the PC must be set.

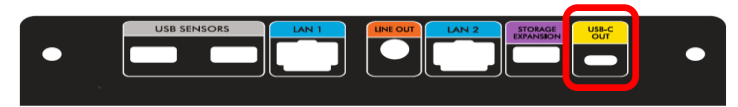
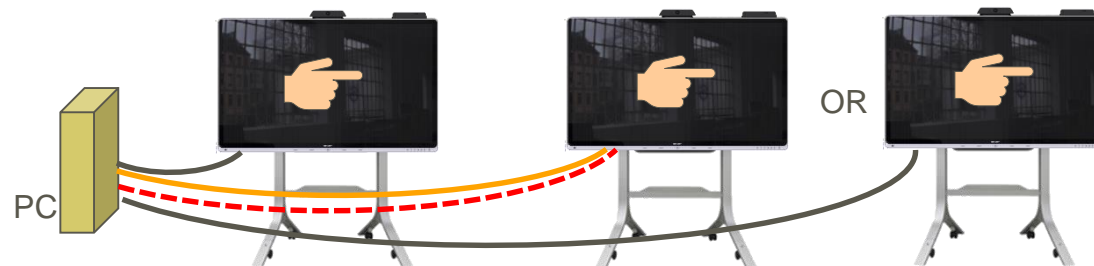

Figure. Rear Left View

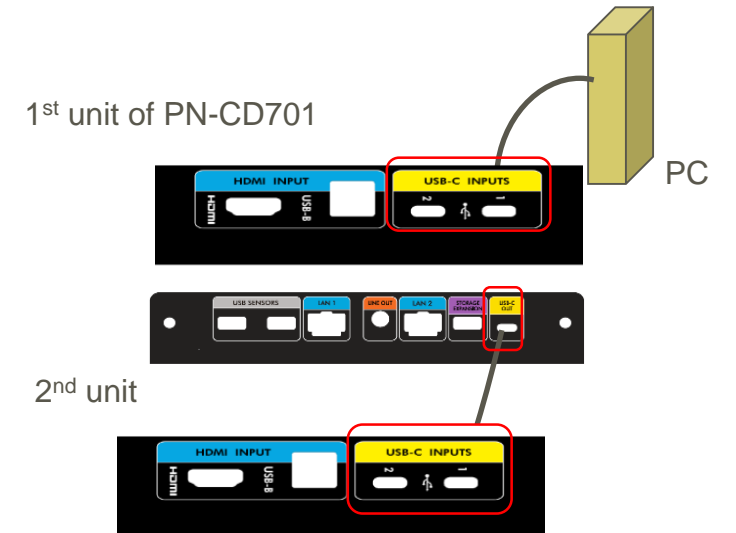

Figure. Daisy chain connection

4. Conditions of network connections to the PN-CD701

4-1. Common functions of both LAN ports

PN-CD701 has 2 wired LAN ports.

One is “LAN 1”, and the other is “LAN 2”.

Each port serves a different function, see below for details of each port.

LAN 1 : LAN port for connecting external PC/s

LAN 1 connection is routed to USB type-C and USB-B ports. The connected PC device will receive internet access via the USB type-C or USB-B port.

(Please confirm this method of network access is acceptable with the network IT administrator).

LAN 2 : LAN port for output data & control of PN-CD701

The port is mandatory for using WSI (Work space intelligence).

Collected data by IoT sensors are uploaded to internet via this LAN port.

Furthermore, the main body will be controlled via this port by using “Crestron connected” devices.

Fig. 1 : Backside of PN-CD701

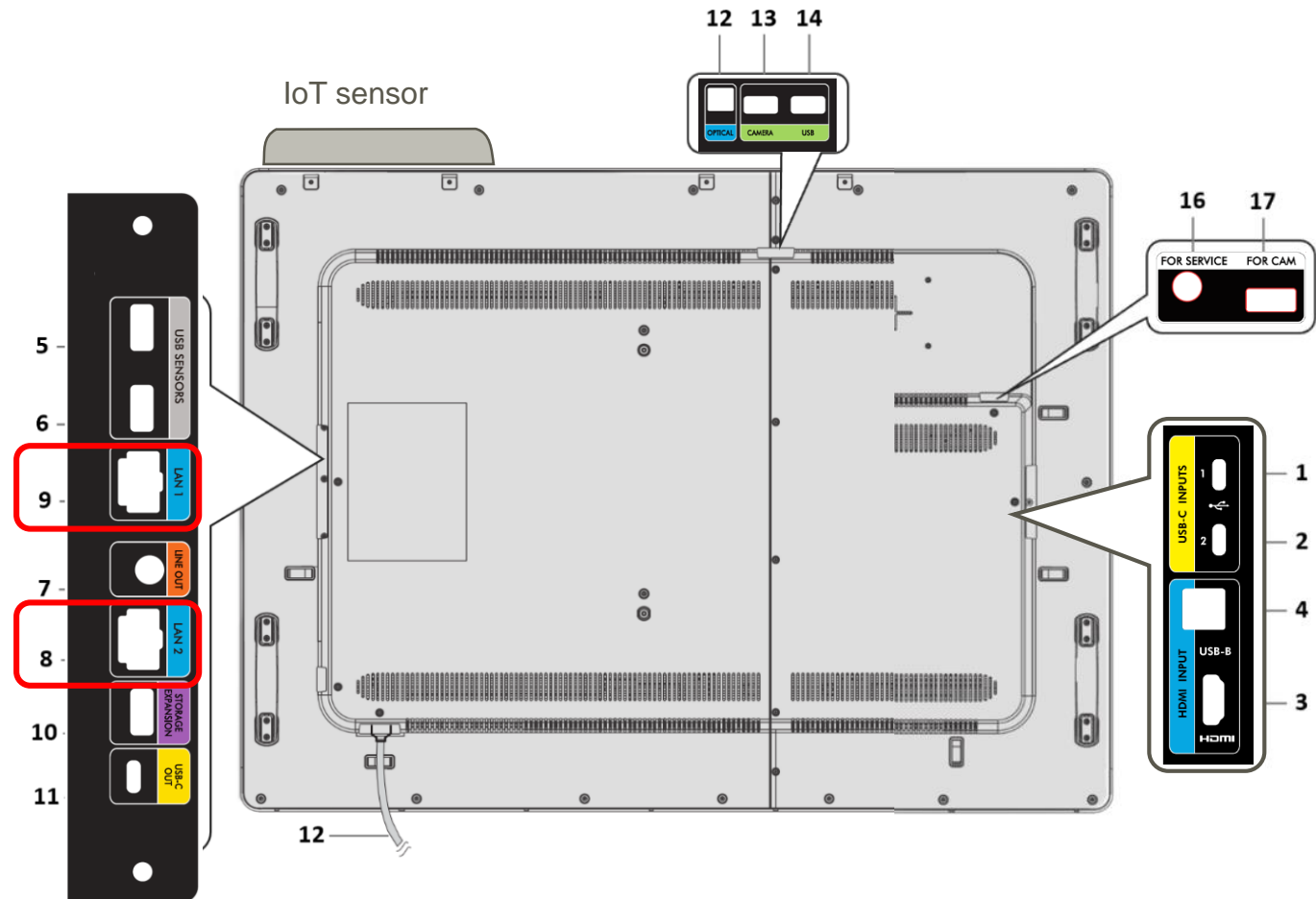

4. Conditions of network connections to the PN-CD701

4-2. Use case

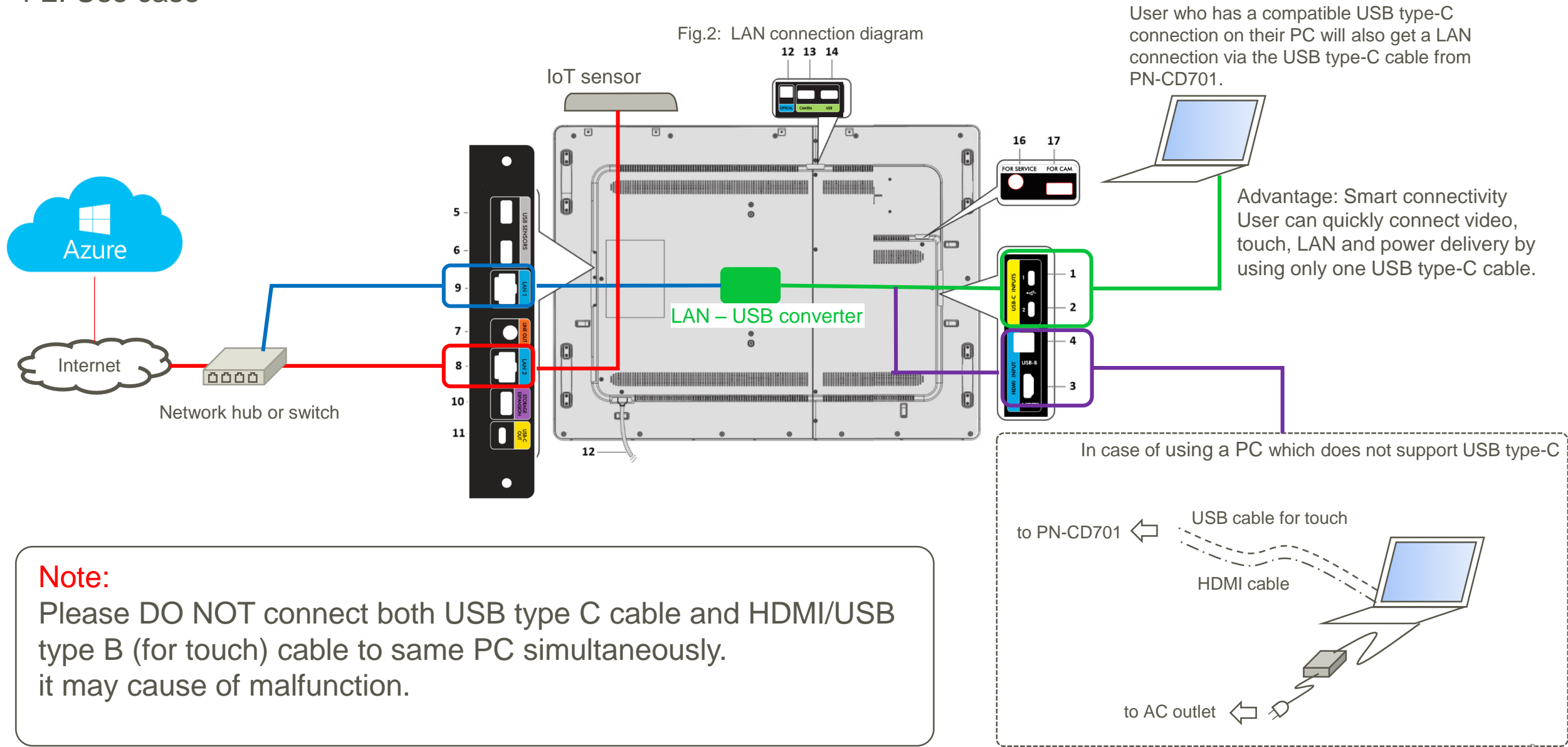

4-3. Technical background

4-3-1. Network isolation

- Each LAN port (LAN 1, LAN 2) are separate and will have different IP addresses.
- There are no network management devices (routers or switches) inside.
- Works with different LAN settings.

“LAN 1” is completely isolated from the internal controller of PN-CD701
So there is no security breach concerns from connected PC devices.

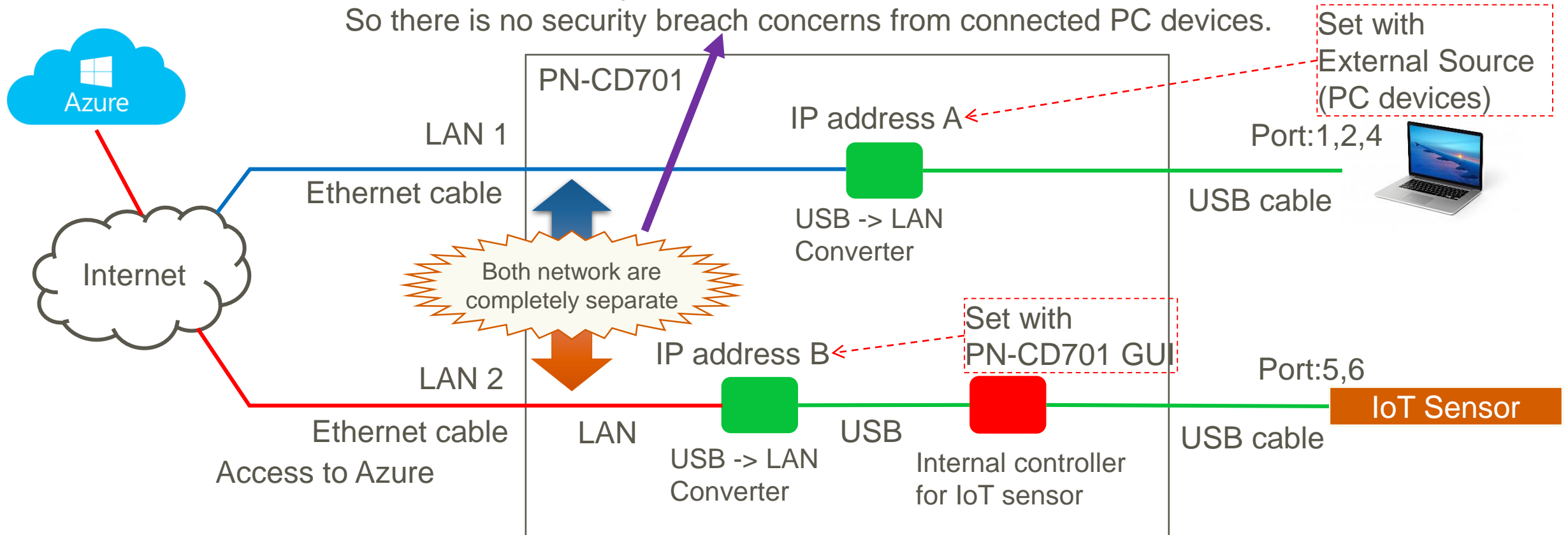

4-3. Technical background

4-3-2. Network requirements for WSI (IoT sensor data)

Tips: Required network connection for IoT sensors is always LAN 2

Internet connections

Internet connections are available using intranet. If network devices filter IoT packets, they can be accessed through router, proxy, GW/FW.

Condition of IP address

It can use DHCP. And supports both IPv4 and IPv6.

Required port(s) for uploading / downloading IoT sensor data

Port number	Protocol	Remarks
8883	MQTT	
443	MQTT over WebSockets	
5671	AMQP	
443	AMQP over WebSockets	
443	HTTPS	

4-3-3. Other network requirements

Port "80" and "843" are required by Crestron connected.

5. Notes on updating firmware

5-1. OOBЕ

Out-Of-Box-Experience(OOBE) is displayed at the first startup or after resetting. Since there is a setting to search for the latest FW in the OOBE setting, Please prepare the Internet environment and execute the update.

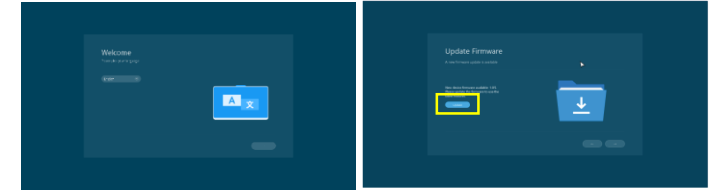

Figure. OOBE

5-2. USB Flash Drive*1

You can update using a USB flash drive. Please perform the following procedure.

1. Please start your computer and Download the “PN-CD701” Zip file from the SHARP Information Display Downloader*2.
2. Unzip the downloaded file and save the “FWU_Config” file and “WCD70” directory to the USB memory directly under the root.
3. Insert the USB flash drive into the USB terminal of “FOR CAM”.
4. Turn on the power switch while pressing the second button from the left as seen from the front.
5. Wait for the update to complete. (Approximately 10 minutes)
Do not turn off the power until the OOBE is displayed as it may cause a malfunction.

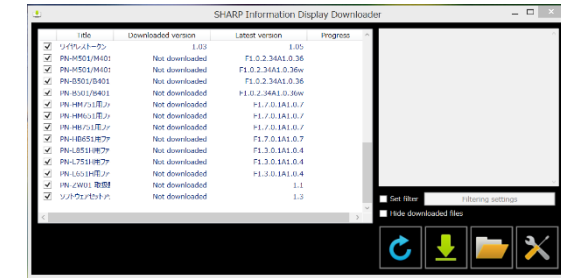

Figure. SHARP Information Display Downloader

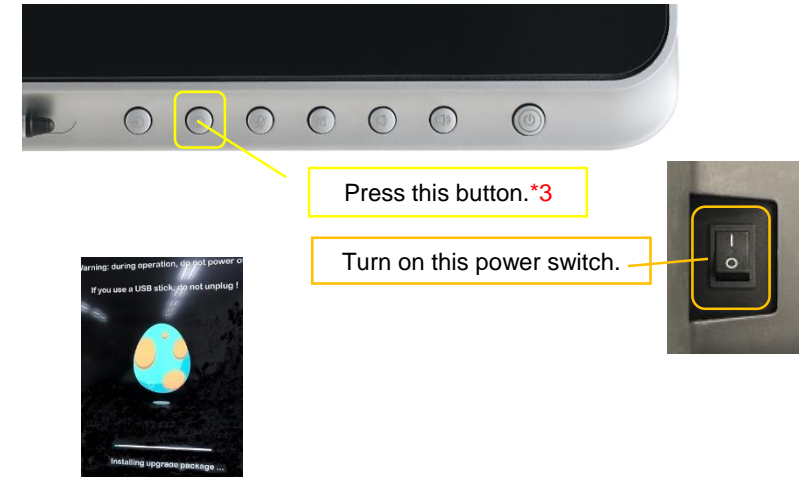

Figure. Egg picture

*1 If the FW update is performed in this way, the setting value will be cleared, so reconfiguration is required.

*2 If you do not have the tool, please contact an authorized SHARP servicing dealer or service center.

*3 Do not let go of the buttons until the “Egg” picture appears on the screen.

5. Notes on updating firmware

5-3. OTA Firmware Updates

Note This method requires a network environment.

If you want to update the FW while keeping the display settings, you can use OTA update.

1. Please open the setting menu of PN-CD701 and press the Admin menu.
2. Click Update in OTA Firmware Updates.

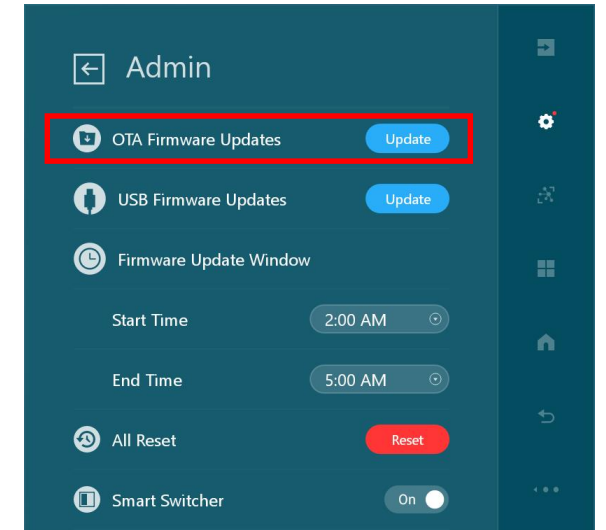
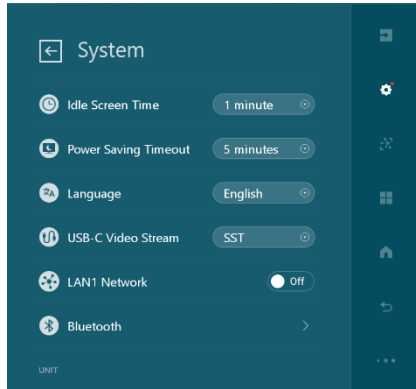

Figure. Admin menu

6. Enable LAN 1 Network

6-1. Procedure to enable LAN1 Network

Access "System" menu



Switch "LAN1 Network" to "on"

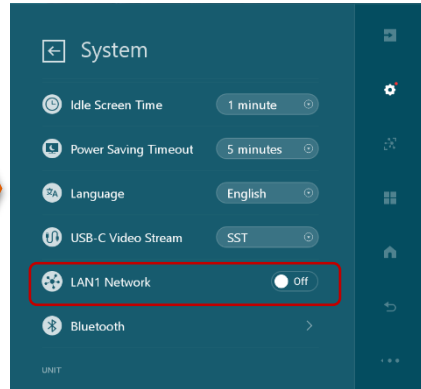

Enter user or admin passcode

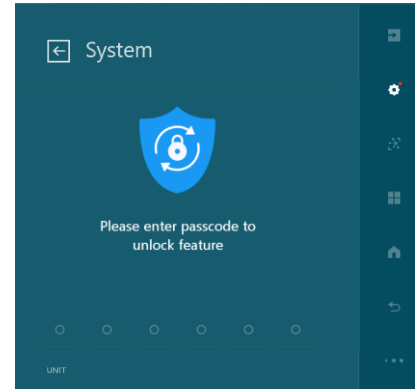

LAN1 Network becomes available

6-2. LAN 1 network always on

If you want to enable LAN1 function permanently, it can be set via "Admin" menu.

Access "Admin" menu

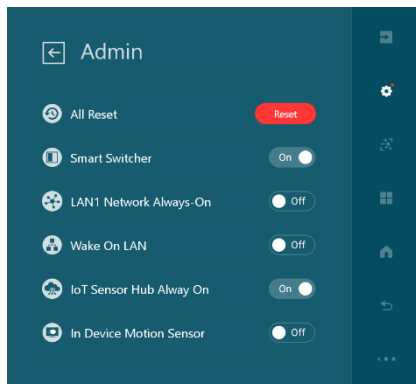

Switch "LAN1 Network Always-on" to "on"

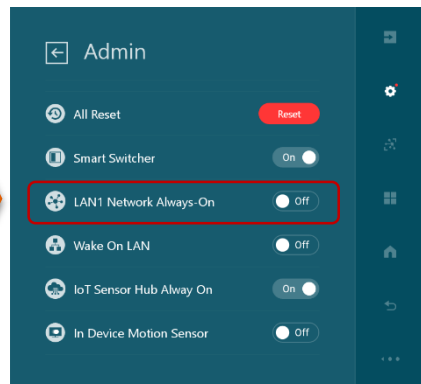

LAN1 Network becomes available permanently
Please consider network security when selecting this option

6. Enable LAN 1 Network

6-3. Matrix of LAN1 Network status

LAN 1 Network will be back to “disable” after disconnect PC devices because of security issue.
(Except when you choose “LAN 1 Network Always-on”.)

E : LAN1 network connection is enable
D : LAN1 network connection is disable

Matrix of LAN1 Network status

	Setting	USB type-C 1		USB type-C 2		USB-B	
		Plug	Unplug	Plug	Unplug	Plug	Unplug
LAN1 Network	ON	E	D*1	E	D*1	E	D*1
	OFF	D	D	D	D	D	D
LAN1 Network Always-on	ON	E	E	E	E	E	E
	OFF	*2	*2	*2	*2	*2	*2

The Setting value of “LAN1 network” is automatically changed to OFF.

- *1 If there are other connected terminals, Network connection will remain enable.
And, setting of “LAN1 network” remains “ON”.
- *2 Depends on setting of “LAN1 Network”.

7. Notes on camera attached to PN-CD701

The camera attached to PN-CD701 supports 4K resolution, but camera video output is Full HD because the cable included with PN-CD701 is a USB2.0 cable.
(Because main application “Teams” and “Skype for Business” camera images are supported up to Full HD.)

If you want to show 4K image with different applications, please prepare the following connection environment.

【Preparation】

Replace the USB2.0 cable that connects camera and PN-CD701 with a USB3.0-compatible cable A-B type.

【How to connect PC and PN-CD701】

- A) Connect HDMI cable and USB3.0 cable.
- B) Connect PC and PN-CD701 with USB Type-C cable, and connect PC and camera with USB3.0 cable.

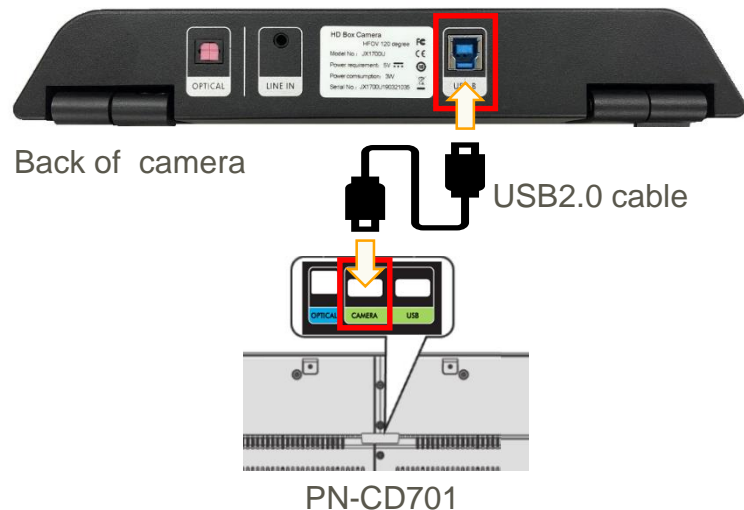

Figure. Preparation

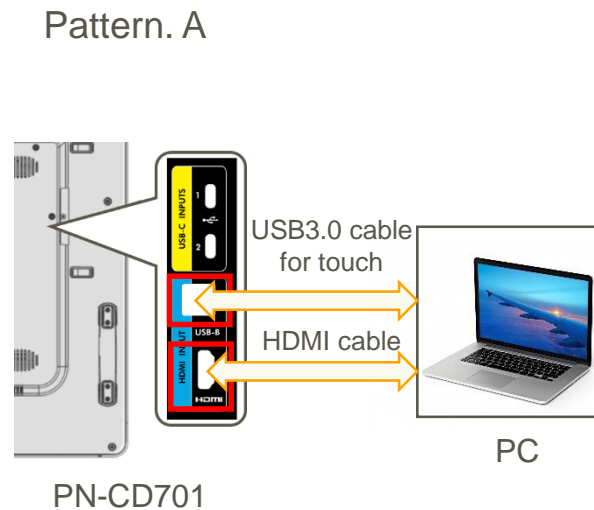
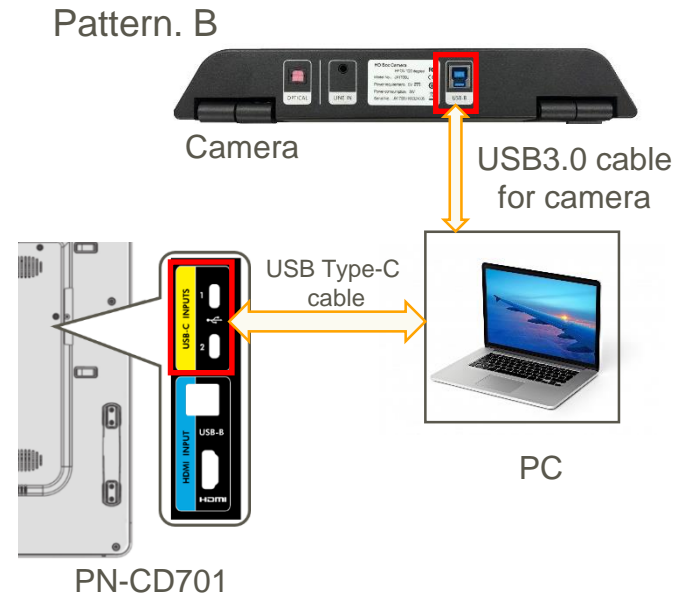

Figure. How to connect PC and PN-CD701



8. Tips

1. What are red dot or bell mark on each icons in PN-CD701?

It indicates something update or attention in each items.

It is same as “Notification dot” which is implemented from Android 8 (Oreo).

Please tap each icons which are displayed red dot / bell to confirm updated information.

2. Wireless display projection conditions

The input of “Wireless Windows” and “Wireless Android” can be displayed by Windows10 or Android terminal that supports Miracast transmission.

- Windows: Windows 10 or later
- Android (version 6.0 or later are recommended)

Connection with all devices is not guaranteed.

Because it depends on the hardware of each terminal, it may not work on supported OS.

3. About WoL (Wake on LAN)

It is an Ethernet or token ring computer networking standard that allows a computer to be turned on or awakened by a network message.

Please ask to consult your IT manager or system integrator to use it.

Basically there are some limitation when you use it.

<Limitation>

- Simple message called “Magic packet” is used for waking up PN-CD701 . “Magic packet” is standard procedure for waking up PC device.
- It is mandatory to use WoL both target machine (PN-CD701) and PC device for control are existed in same network segment.
- When you use WoL , it is mandatory to set both target machine (PN-CD701) and controller (PC device) in same network segment
- Mac address of target machine is necessary. You can check it form PN-CD701’s menu
“Settings” → “Network” * It is mandatory to connect LAN cable

4. About data acquired by IoT sensor

Values such as temperature, humidity, and illuminance acquired by the IoT sensor are measured values near the PN-CD701, not average values in the room being used.

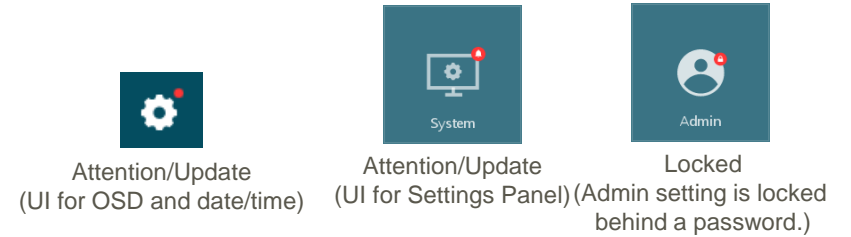

9. Detail of setting menu items

Menu Items

Menu item details

The menu will differ depending on the input mode.

Quick Settings

Volume

Adjusts the volume. (0-100%)
Temporarily mutes the audio.

Mic toggle

Toggle the microphone. Set whether to use a microphone.

Brightness

Adjusts the backlight brightness. (0-100)

Applications

Applications

Display the added app list. When you select an app, you can run that app.

Display

White Balance

Set whether to adjust white balance. When set to OFF, the input signal level is output as is.

Contrast

Adjusts the difference between the bright and dark portions of the image.

Sharpness

Adjusts the sharpness of the image.

Color

Adjusts the color intensity.

Tint

Adjusts the hue. Selecting + changes the color towards green, and selecting - changes it towards magenta.

SOURCES ALIAS

For each terminal, you can change the input mode name that is displayed during input mode selection or display.
The names of *USB-C 1, *USB-C 2 and *HDMI can be changed. (*Factory default.)

Network

TCP/IP

If your LAN has DHCP server and you wish to obtain an address automatically, change this setting to DHCP.

To set the address manually, set this to Manual.

IP Address Set the IP address.

Default Gateway Specify the default gateway. If you are not using a gateway, specify "000.000.000.000".

DNS1 Specify the DNS server address. If you are not using a DNS server, specify "0.0.0.0".

DNS2 Specify the DNS server address. If you are not using a DNS server, specify "0.0.0.0".

Subnet Mask Specify the subnet mask.

MAC Address Confirm MAC Address.

Proxy

When using this monitor in the proxy environment, set to Manual.

Proxy Port Set a port number when connecting to the proxy server.

Proxy Exclude List Set the address do not use proxy server.

9. Detail of setting menu items

Menu Items

System

High Contrast

Emphasizes the difference between the bright and dark portions of the image.

Font Size

Adjust the font size.

24-Hour Time

Sets the time display format.

Set Automatically

Set time and date automatically.

Date Set the date.

Time Set the time.

Time Zone

Sets the time zone.

Idle Screen Time

Adjusts the sharpness of the image.

Power Saving Timeout

Set the monitor to go into standby mode, backlight off mode, backlight reduction mode when the set time has passed with no operation or no signal.

Language

Sets the display language for the menu screen.

USB-C Video Stream

Set how DisplayPort is used.

SST Use as single stream (DisplayPort1.2).

MST Use as multi-stream (DisplayPort1.2).

(This may not display correctly, depending on the computer (video card) that is connected.)

LAN1 Network

Set whether to enable or disable the LAN1 network. The setting will be reset when you unplug the USB cable or when display goes into standby mode, backlight off mode or backlight reduction mode.

When changing this setting, a user passcode is required.

Bluetooth

Set whether to enable or disable Bluetooth. Select the device to connect via Bluetooth.

Temperature

Select temperature display in Celsius or Fahrenheit.

Menu Items

Sensor Hub

Enable Sensors

Set whether to enable the IoT sensor.

Device Information

OS/OS version

Shows the monitor version.

Model

Shows the monitor model name.

Hardware ID/Serial number

Shows the monitor serial number.

Software License

Shows the software license agreement.

Open Source Library

Shows the open source library.

E-Manual

Display the instruction manual.

9. Detail of setting menu items

Menu Items

Admin

Edit Information	Edits the SSID of wireless LAN.
Choose A New Wallpaper	Change the wallpaper of Home screen.
Install New Apps	Install the new application. (1) Save the file (*.apk) to which the application can be installed to USB memory. (2) Insert a USB memory into USB port "FOR CAM" or "storage expansion". (3) Press "Choose" to scan USB memory. (4) If there is an app that can be installed, that app will be displayed as a list. Select the app you want to install. (5) Check the check box and select Yes.
Country	Select the country where the monitor is installed.
Province / Region / State	Select the province / region / state where the monitor is installed.
City	Select the city where the monitor is installed.
Operation Mode	US MODE1 Wake On LAN is set to ON, In-Device Motion Sensor is set to ON, and IoT Sensor Hub Always On is set to OFF. (These settings can not be changed.) MODE2 Wake On LAN is set to ON, In-Device Motion Sensor is set to ON, and IoT Sensor Hub Always On is set to ON. These settings can be changed. EU MODE1 Wake On LAN is set to OFF, In-Device Motion Sensor is set to OFF, and IoT Sensor Hub Always On is set to OFF. (These settings can not be changed.) MODE2 Wake On LAN is set to ON, In-Device Motion Sensor is set to ON, and IoT Sensor Hub Always On is set to ON. These settings can be changed.
Change User Passcode	Set a passcode for the user.
Change Admin Passcode	Set a passcode for the Administrator.
OTA Firmware Updates	Update the firmware from the network.
USB Firmware Updates	Update the firmware from the USB memory.
Automatic Updates	Set whether to perform firmware update automatically.
Firmware Updates Window	Set the start time and end time of Windows update. Start Time Set the start time of Windows update. End Time Set the end time of Windows update.
All Reset	Resets the settings to the factory default settings.
Reset Wireless LAN	Reset the Wireless LAN settings.
Smart Switcher	Sets whether the input into the input terminal automatically changes when a video signal is input into that terminal.
LAN1 always-on connection	Set the LAN1 network setting to always ON.
Wake On LAN	Set whether to enable Wake On LAN.
IoT Sensor Hub Always On	Set whether to always use the IoT sensor. When this setting is ON, data collected by the IoT sensor is always uploaded to the cloud. US The backlight turns off when the power button is pressed, but the IoT sensor continues to operate, resulting in higher power consumption than in standby mode. EU Although pressing the power button reduces the brightness of the backlight, the IoT sensor continues to operate, resulting in higher power consumption than in Standby mode.
In Device Motion Sensor	Set whether to use motion sensor. When using a motion sensor, the monitor will resume from standby mode if motion is detected in front of the monitor.

SHARP

Be Original.